

en-EN

## Operating Manual Electrical Combisteamer

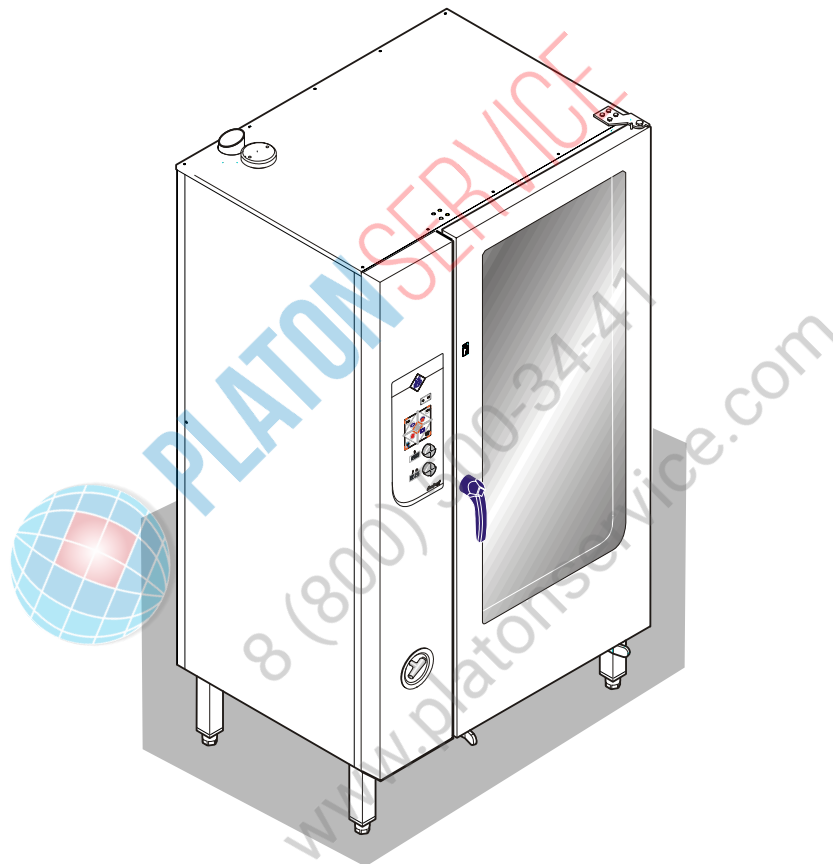

Model	Model No.
Electrical Combisteamer 6.1	CSE61XXXX
Electrical Combisteamer 6.2	CSE62XXXX
Electrical Combisteamer 10.1	CSE11XXXX
Electrical Combisteamer 10.2	CSE12XXXX
Electrical Combisteamer 20.1	CSE21XXXX
Electrical Combisteamer 20.2	CSE22XXXX

## Keypad and display

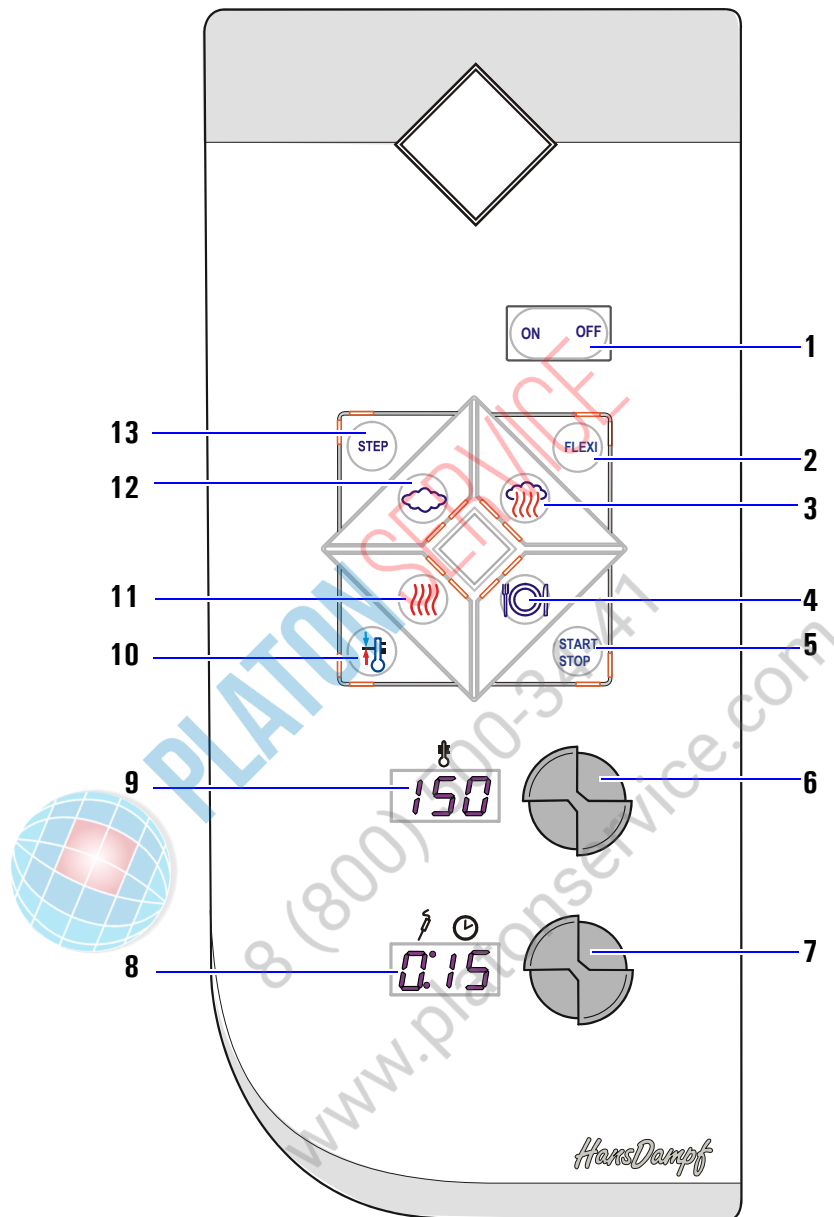

- |                                      |                                                |
|--------------------------------------|------------------------------------------------|
| 1 ON/OFF button                      | 8 Bottom display for core temperature and time |
| 2 "FLEXI" button with LED            | 9 Top display for temperature                  |
| 3 "Combisteam" button with LED       | 10 "Preheat" button with LED                   |
| 4 "Regenerate" button with LED       | 11 "Convection" button with LED                |
| 5 "START/STOP" button with LED       | 12 "Steam" button with LED                     |
| 6 Adjustment knob for top display    | 13 "STEP" button with LED                      |
| 7 Adjustment knob for bottom display |                                                |

# Contents

<b>Appliance description .....</b>	<b>7</b>
Intended use .....	7
Improper use .....	7
Dangers of improper use .....	7
Instruction of operating personnel .....	7
Door lock of HansDampf 6X and 10X .....	10
Door lock of HansDampf 20X .....	11
<b>Operation.....</b>	<b>13</b>
Operating modes.....	13
Additional functions .....	13
Selecting steaming .....	14
Setting temperature.....	14
Setting time .....	14
Setting core temperature .....	14
Starting steaming.....	15
Completion of steaming .....	15
Selecting combisteaming.....	16
Setting temperature.....	16
Setting time .....	16
Setting core temperature .....	16
Starting combisteaming .....	17
Completion of combisteaming.....	17
Selecting convection .....	18
Setting temperature.....	18
Setting time .....	18
Setting core temperature .....	18
Setting Drytronic (optional) .....	19
Starting convection cooking .....	19
Completion of convection cooking.....	20
Selecting regeneration .....	21
Setting temperature.....	21
Setting time .....	21
Setting core temperature .....	21
Starting regeneration .....	22
Completion of regeneration .....	22
Display content during a cooking process .....	23
Making changes during a cooking process .....	23

Multi-step cooking programs.....	24
Starting multi-step program .....	25
Which program step is active? .....	25
Completion of multi-step cooking program.....	25
Restarting multi-step cooking program .....	25
Which cooking process should use core-temperature measurement? .....	26
Core-temperature probe versions.....	27
Positioning the core-temperature probe .....	27
Default settings .....	28
Calling up setting menu.....	28
Selecting parameters .....	28
Changing parameters .....	28
Accepting parameters .....	28
Parameter listStart display .....	29
<b>Additional functions .....</b>	<b>31</b>
Setting starting time pre-selection .....	31
Starting waiting time .....	31
End of waiting time .....	31
Cancelling starting time pre-selection.....	31
Starting preheating .....	32
Completion of preheating .....	32
<b>Practical tips.....</b>	<b>33</b>
Advantages of steaming.....	33
Important information to be heeded .....	33
Steaming tips .....	33
Advantages of soft steaming .....	34
Important information to be heeded .....	34
Soft steaming tips .....	34
Advantages of express steaming.....	35
Important information to be heeded .....	35
Express steaming tips: .....	35
Advantages of combisteaming .....	35
Important information to be heeded .....	36
Combisteaming tips .....	36
Important information to be heeded .....	36
Convection cooking tips: .....	36
Advantages of regeneration.....	37
Important information to be heeded .....	37

---

Regeneration tips .....	38
Regeneration guidelines .....	38
<b>Cleaning .....</b>	<b>39</b>
Safety information .....	39
Cleaning outer housing .....	39
Cooking chamber cleaning systems .....	39
Cleaning the door .....	40
Back-ventilated door .....	40
Removal and installation of the inner pane:.....	41
Cleaning door seal .....	41
Preparation of cooking chamber .....	42
Starting manual cleaning .....	42
Cooking chamber too hot .....	43
Soaking .....	43
Spraying in cleaner .....	43
Cleaning (working in) .....	44
Cleaning .....	44
Rinsing .....	44
Drying .....	44
Manual cleaning .....	45
Decalcification .....	45
"two-in-one" combination cartridge .....	46
Storage of cartridges .....	46
Preparing cooking chamber .....	46
Selecting cleaning level .....	47
Starting WaveClean .....	47
Cooking chamber too hot .....	47
Inserting cartridge .....	48
Cancelling "WaveClean" .....	49
Completion of "WaveClean" .....	50
"WaveClean" malfunctions .....	51
Lime depositing with "WaveClean" .....	51
"WaveClean extra" .....	51
Additional rinse water cartridge .....	52
Manual decalcification .....	52
Water softening .....	52

<b>Malfunctions .....</b>	<b>53</b>
Fault display .....	53
Resetting (initialising) control electronics .....	54
<b>HACCP .....</b>	<b>55</b>
Printing logs .....	55
The HACCP log.....	56
<b>Declaration of conformity .....</b>	<b>57</b>



**PLATON SERVICE**

8 (800) 500-34-41

[www.platonservice.com](http://www.platonservice.com)

---

## Appliance description

**Intended use** The MKN Combisteamer is designed for commercial use. It has not been tested according to the regulations and standards for household appliances.

MKN accept no liability and make no guarantee with regard to operation as a household appliance!

The Combisteamer may only be used to cook food with grills, containers, baking sheets, transport trolleys and inserts applicable for the appliance.

Only clean drinking water may be used for steam generation in the appliance.

**Improper use** The Combisteamer may not be used for the following purposes:

- as a storage cabinet
- as a smoker
- to dry towels or cutlery
- to heat acids, bases or any other chemicals
- to heat flammable liquids
- to melt greases or salts
- to heat rooms
- to fry foods
- to heat closed containers, e.g. tins
- as a dishwasher
- to clean air filters
- Operation without slide-in rails/transport trolley

**Dangers of improper use** If used improperly, the appliance can be permanently damaged and the operating personnel subjected to a danger to life and limb.

**Instruction of operating personnel** Before the initial commissioning of the appliance, operating personnel are to be informed of remaining dangers that are present despite proper operation of the appliance, as well as the behaviour of the appliance in case of malfunctions or fire.



### Safety information

MKN Combisteamers comply with all European safety standards. This does not exclude all possible dangers, e.g. those which could arise due to faulty operation. The following safety information must be heeded during operation for this reason:



#### **Danger of scalding from sloshing hot liquid!**

Cooking containers holding foods that liquefy during cooking (decoction, meat juice) are not to be inserted above eye level, i.e. the cooking food must always be viewable.



#### **Danger of scalding from escaping steam!**

If the door is opened during operation, large quantities of steam can escape, especially during steaming. For this reason, open the door just slightly at first to allow the steam to dissipate and then open it fully. Steam is blown off through the air vent while the cooking chamber is being dehumidified. For this reason, do not look into the air vent or hold your hand over it.



#### **Danger of burns from hot grills and containers!**

Use insulated gloves to pull or move out hot grills or containers. Always open appliance door fully until it stops and locks. Do not touch the interior of the steamer and inside of the door!



#### **Danger of chemical burns from cleaning agents!**

Always wear protective gloves and goggles when cleaning the interior of the steamer with caustic cleaning agents. Comply with the information from the manufacturer.



**Appliances featuring "WaveClean" cleaning must always be connected to hard and soft water so as to prevent damage!**



The appliance may only be cleaned and serviced when cooled down (below 60 °C).



**Do not cool cooking chamber abruptly!**

When cooling down, do not spray the hot cooking chamber or the appliance door with cold water from the hand shower. Abrupt cooling can deform the cooking interior and crack the insulating glass pane of the door.



**Do not clean appliance with a high-pressure water or steam jet!**

With Combisteamers 20.1/20.2, the transport trolley must always be inserted during operation so that the door is properly sealed.



**Do not operate appliance if door seal is damaged!**

Ripped or damaged door seals can lead to damage to electrical and electronic components. Authorised customer service should be commissioned to change the seals. The door seal is inserted. Ensure proper seating during assembly, i.e. the seal must be fully inserted into the seal seat and be fixed there. Grease, high temperatures and cleaning residue shorten the service life of the door seal. Avoid continuous operation at high temperatures and remove grease and cleaner residue regularly.

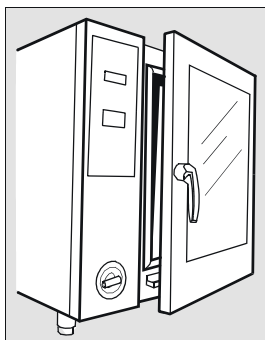

**Do not operate appliance if glass panes are broken!**

If glass panes are broken (cooking chamber illumination and door glass), the appliance may no longer be operated. If a glass pane were to break while food was found in the cooking chamber, this food must be disposed of (danger of glass shards!)

Due to the good isolation properties of the appliance door, the insulating glass panes can become clouded from the inside if the appliance is not used for a longer period of time. This effect is a result of the design of the appliance and does not indicate a fault or defect.

Once the appliance is used again, this will disappear after a short time.



**Do not close the appliance door during periods of non-use; you should leave it open slightly!**

Do not commission appliance if operating film is damaged (torn)

Door lock of  
HansDampf 6X and 10X



### Opening

1. Turn door handle to the right or left.  
The door then opens.

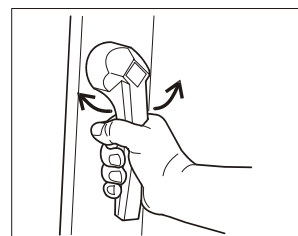

2. Open the door fully. If the door handle is released, it returns to the vertical position.

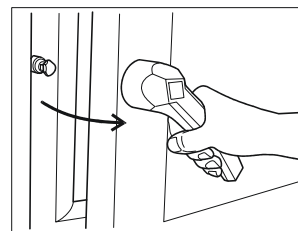

### Closing

Press the door closed with door handle vertical.

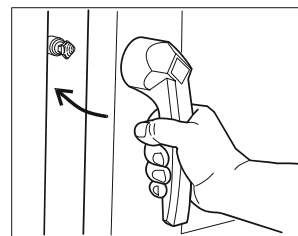

## Door lock of HansDampf 20X

### Opening

1. Turn the door handle to the right to a horizontal position.

The door then opens, but remains engaged.

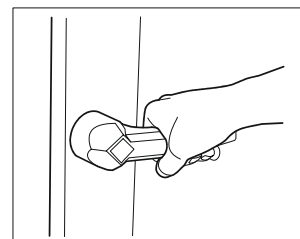
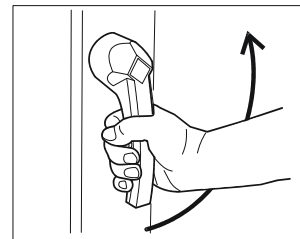

2. Turn door handle further upward: The door then disengages.

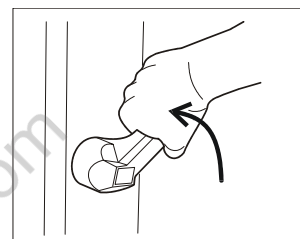

3. Allow the door handle to spring back to the horizontal position and open the door fully.

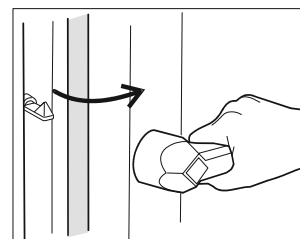

### Closing

1. Press the door closed with the door handle horizontal.

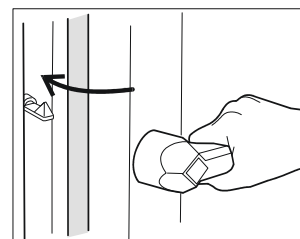

2. The door is locked by turning the door handle to the vertical position.

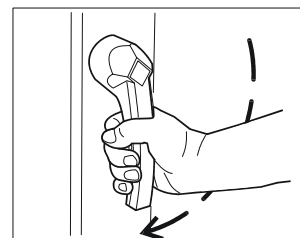

PLATON SERVICE  
8 (800) 500-34-47  
www.platonservice.com

### HansDampf models

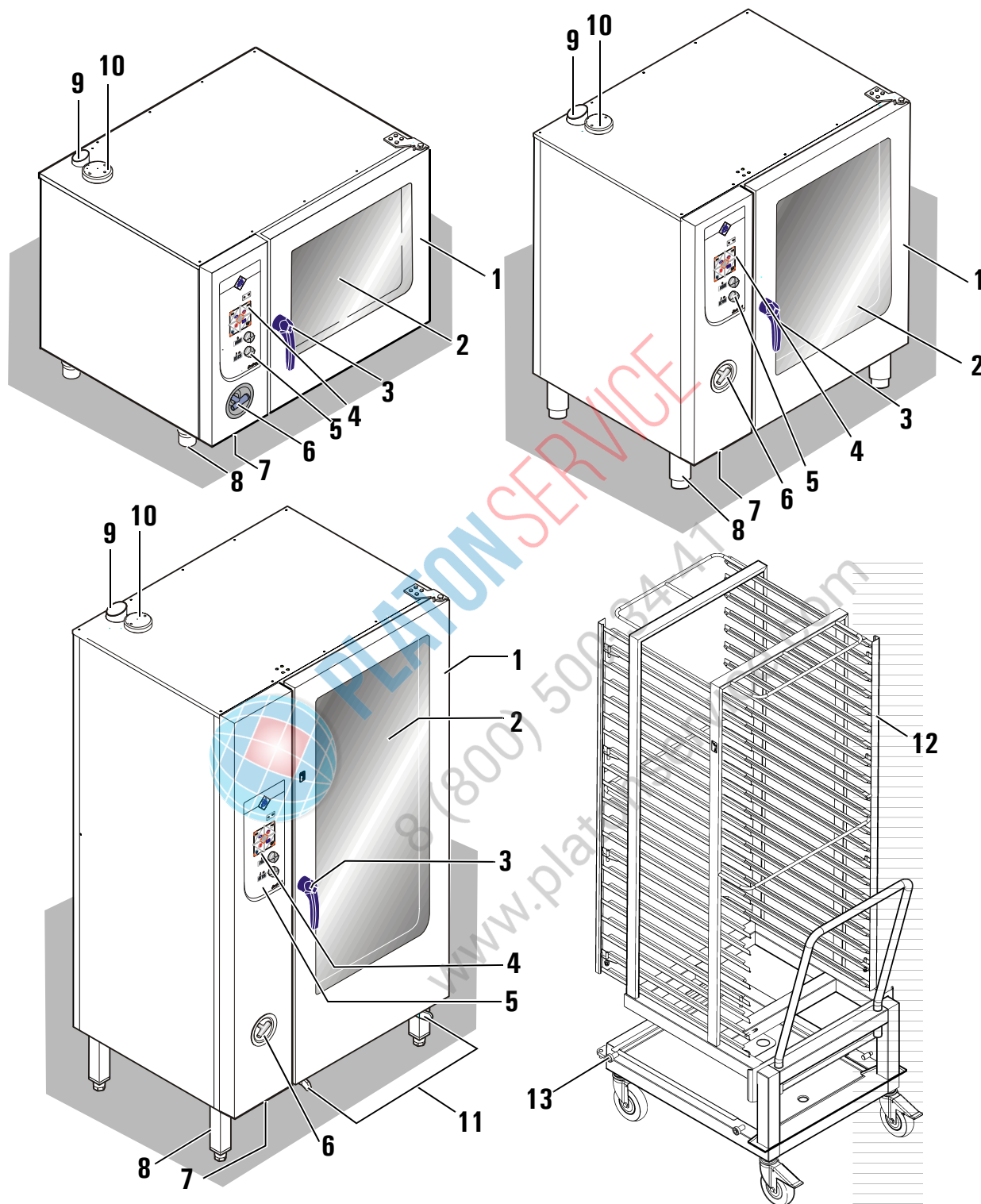

#### **Electrical Combisteamers 6.X, 10.X and 20.X**

- |                                         |                                                    |
|-----------------------------------------|----------------------------------------------------|
| 1-Appliance door                        | 8-Vertically-adjustable appliance feet             |
| 2-Insulating glass pane                 | 9-Steam outlet vents                               |
| 3-Door handle                           | 10-Air intake vents for cooking chamber (optional) |
| 4-Film keypad with display              | 11-Retainer rails for transport trolley            |
| 5-Adjustment knobs                      | 12-Transport trolley                               |
| 6-Hand shower with retractor (optional) | 13-EasyIn (optional with 20.1)                     |
| 7-Data interface                        |                                                    |

---

# Operation

**Operating modes** Food can be cooked in a variety of operating modes with the Combisteamer

- Steaming
- Combisteaming
- Convection
- Regeneration

**Additional functions** Cooking processes can be adjusted individually using functions such as:

- Starting time pre-selection
- Preheating
- Manual steam injection
- Drytronic (optional)



PLATON SERVICE  
8 (800) 500-34-41  
www.platonservice.com

### Steaming

#### Selecting steaming

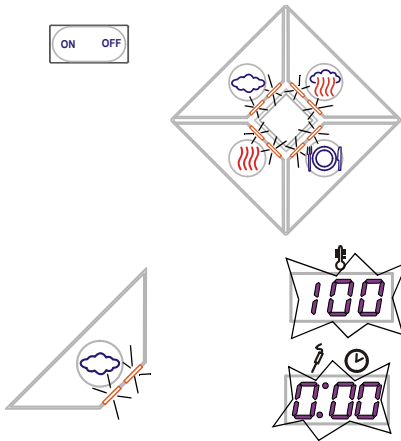

You can cook, steam, blanch and preserve food with the "Steaming" program.

Switch the Combisteamer on with the "ON/OFF" button.

- The LEDs of the four cooking mode buttons illuminate.

Press the "Steam" cooking mode button.

- The LEDs of the cooking mode button illuminate.
- The top display shows a flashing "100" (°C).
- The top display for time/core shows a flashing "0:00".

#### Setting temperature

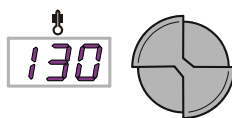

Set the temperature by turning the adjustment knob.

**Soft steaming:** 30 °C to 99 °C.

**Steaming:** 100 °C.

**Express steaming:** 101 °C to 130 °C.

#### Setting time

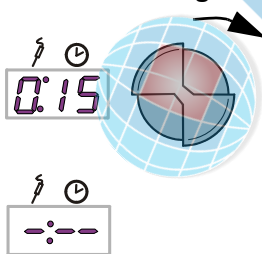

Set the cooking time by turning the adjustment knob to the **right**.

Setting range: 1 minute – 24 hours

Up to 9:59 in 1-minute increments, then in 10-minute increments.

**Continuous operation:** With a time display of "0:00", turn the adjustment knob to the left until "---" for continuous operation appears in the display.

#### Setting core temperature

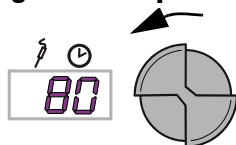

Set the core temperature by turning the adjustment knob to the **left**.

Setting range from 99 - 30 (°C) in 1-degree increments.

## Starting steaming

Place food into the Combisteamer and close the door. If steaming is to be carried out with core-temperature measurement, insert the core-temperature probe into the food beforehand as described in the "Core-temperature measurement" section.

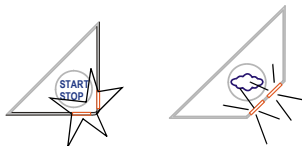

Press the "START/STOP" button.

- The LEDs of the "START/STOP" button flash.
- The LEDs of the "Steam" button illuminate.
- The top display shows the selected cooking temperature. The dot next to the temperature indicates that heating is activated.
- The top display for time/core shows: the **remaining cooking time** (with continuous operation "---") or the **setpoint core temperature**.

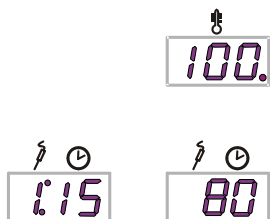

## Completion of steaming

The cooking process is complete once the cooking time has expired or the core temperature has been reached.

The LEDs of the "START/STOP" button go out.

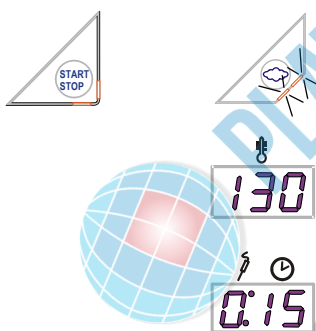

- The signal sounds continuously for 20 seconds. The signal can be switched off earlier by pressing the "START/STOP" button or opening the appliance door.
- The "Steam" button illuminates.
- Both displays then show the settings active when the process was started, **i.e. changes made during the cooking process are not saved!**

The cooking process can be restarted by pressing the "START/STOP" button again.

### Combisteaming

#### Selecting combisteaming

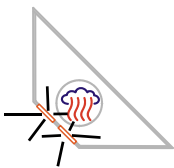
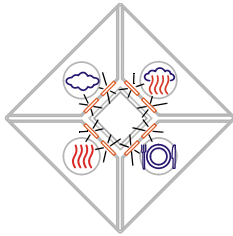

Combisteaming is especially ideal for large roasts and baked goods.

Switch the Combisteamer on with the "ON/OFF" button.

- The LEDs of the four cooking mode buttons illuminate.

Press the "Steam" cooking mode button.

- The LEDs of the cooking mode button illuminate.
- The top display shows a flashing "150" (°C), i.e. the presetting.
- The top display for time/core shows a flashing "0:00", i.e. the presetting.

#### Setting temperature

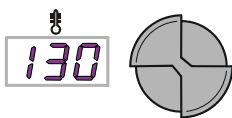

Set the temperature by turning the adjustment knob. Setting range: 30 - 250 °C in 1-degree increments  
Presetting: 150 °C

#### Setting time

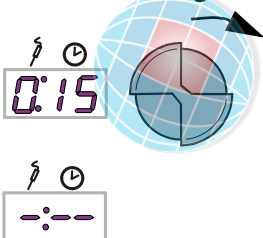

Set the cooking time by turning the adjustment knob to the **right**.

Setting range: 1 minute – 24 hours

Up to 9:59 in 1-minute increments, then in 10-minute increments.

**Continuous operation:** With a time display of "0:00", turn the adjustment knob to the left until "---" for continuous operation appears in the display.

#### Setting core temperature

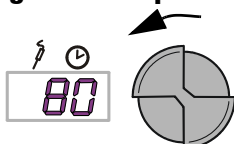

Set the core temperature by turning the adjustment knob to the **left**.

Setting range from 99 - 30 (°C) in 1-degree increments.



## Starting combisteaming

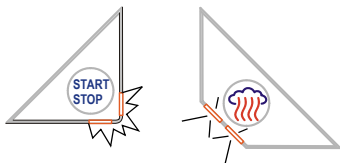

Place food into the Combisteamer and close the door. If combisteaming is to be carried out with core-temperature measurement, insert the core-temperature probe into the food beforehand as described in the "Core-temperature measurement" section.

Press the "START/STOP" button.

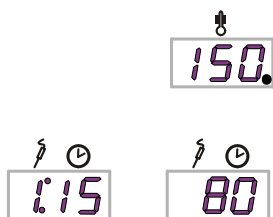

- The LEDs of the "START/STOP" button flash.
- The LEDs of the "Combisteam" button illuminate.
- The top display shows the selected cooking temperature. The dot next to the temperature indicates that heating is activated.
- The top display for time/core shows: the **remaining cooking time** (with continuous operation "---") or the **setpoint core temperature**.

## Completion of combisteaming

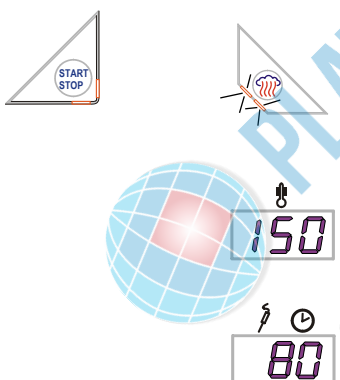

The cooking process is complete once the cooking time has expired or the core temperature has been reached.

The LEDs of the "START/STOP" button go out.

- The signal sounds continuously for 20seconds. The signal can be switched off earlier by pressing the "START/STOP" button or opening the appliance door.
- The "Combisteam" button illuminates.
- Both displays then show the settings active when the process was started. **Changes made during the cooking process are not saved!**

The cooking process can be restarted by pressing the "START/STOP" button again.

### Convection

#### Selecting convection

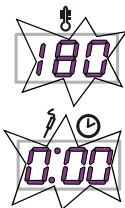
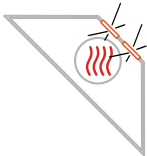
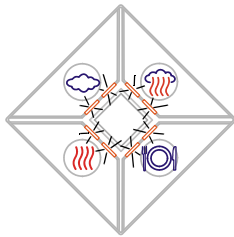

"Convection" cooking is ideal for products not requiring humidity.

Switch the Combisteamer on with the "ON/OFF" button.

- The LEDs of the four cooking mode buttons illuminate.

Press the "Convection" button.

- The LEDs of the cooking mode button illuminate.
- The top display shows a flashing "180" (°C), i.e. the presetting.
- The top display for time/core shows a flashing "0:00", i.e. the presetting.

#### Setting temperature

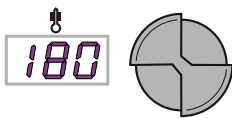

Set the temperature by turning the adjustment knob. Setting range: 30 - 250 °C in 1-degree increments. Presetting: 180 °C.

#### Setting time



Set the cooking time by turning the adjustment knob to the **right**.

Setting range: 1 min to 9 h 59 min.

In 1-minute increments, presetting: 0:00.

Continuous operation: Turn the adjustment knob to the left until "----" for continuous operation appears in the display.

#### Setting core temperature

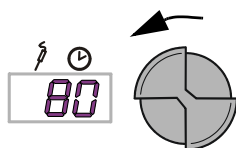

Set the core temperature by turning the adjustment knob to the **left**.

Setting range from 99 - 30 (°C) in 1-degree increments.

## Setting Drytronic (optional)

The steam quantity can be set to 0 or 100% when convection cooking via the "Drytronic" function.

An appropriate cooking chamber humidity can be achieved for food containing a lot of water by setting the steam quantity to 0%.

The excess steam is extracted from the cooking chamber, condensed and blown out.

With a setting of 100%, the cooking chamber humidity can rise to 100%, depending on the product type and quantity.

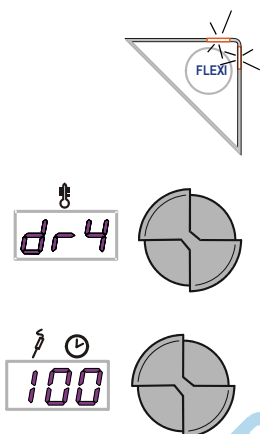

Press the "FLEXI" button:

- The button LEDs illuminate.
- The top display shows "dry" to indicate Drytronic.
- The bottom display shows "100" to indicate 100%.

Set "0" or "100" with the adjustment knob.

Press the "FLEXI" button once again.

- The button LEDs go out.
- Once again, the displays show the temperature and time values for convection cooking.

## Starting convection cooking

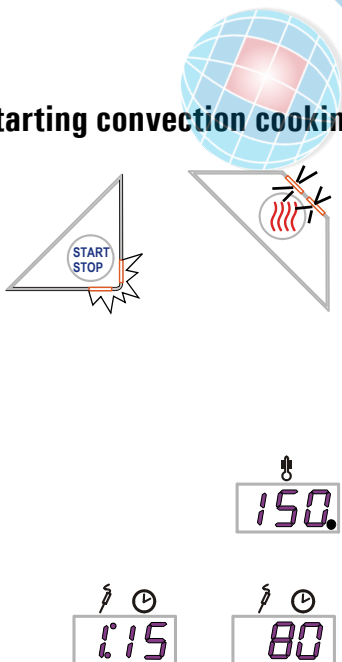

Place food into the Combisteamer and close the door. If convection cooking is to be carried out with core-temperature measurement, insert the core-temperature probe into the food beforehand as described in the "Core-temperature measurement" section.

Press the "START/STOP" button.

- The LEDs of the "START/STOP" button flash.
- The LEDs of the "Convection" button illuminate.
- The top display shows the selected cooking temperature. The dot next to the temperature indicates that heating is activated.
- The bottom display shows the **remaining cooking time**(with continuous operation "---") or the **set-point core temperature**.

### Completion of convection cooking

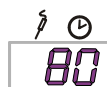
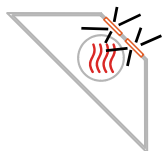
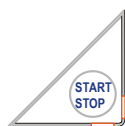

The cooking process is complete once the cooking time has expired or the core temperature has been reached.

The LEDs of the "START/STOP" button go out.

- The signal sounds continuously for 20 seconds. The signal can be switched off earlier by pressing the "START/STOP" button or opening the appliance door.
- The "Convection" button illuminates.
- Both displays then show the settings active when the process was started. **Changes made during the cooking process are not saved!**

The cooking process can be restarted by pressing the "START/STOP" button again.



PLATON SERVICE  
8 (800) 500-34-41  
www.platonservice.com

## Regeneration

### Selecting regeneration

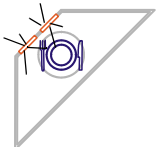

Food on dishes or platters can be regenerated with the "Regeneration" program without a drop in quality. The circulation blower has a special setting in this operating mode.

Dish capacity for regeneration			
HansDampf size	on 1/1 GN insertion grill		on transport frame
	Dish diameter		
	26 cm	28 cm	32 cm
6.1/6.2	30	24	22
10.1/10.2	50	40	40
20.1	100	80	80
20.2	120	120	80

Switch on the Combisteamer with the "ON/OFF" button.

Press the "Regenerate" selector button > "120 °C" and "0:00" appear in the display.

### Setting temperature



Set the temperature by turning the adjustment knob to the right.

Setting range: 30 - 180 °C in 1-degree increments. Presetting: 120 °C.

### Setting time

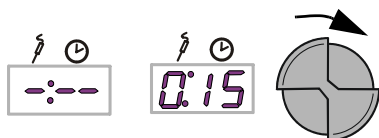

Set the cooking time by turning the adjustment knob to the right.

Setting range: 1 min to 9 h 59 min.

In 1-minute increments, presetting: 0:00

Continuous operation: Turn the adjustment knob to the left until "---" appears in the display.

### Setting core temperature

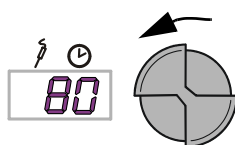

Set the core temperature by turning the adjustment knob to the left.

Setting range from 99 - 30 (°C) in 1-degree increments.

### Starting regeneration

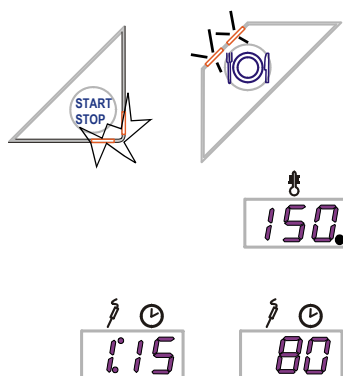

Place food into the Combisteamer and close the door. If regeneration is to be carried out with core-temperature measurement, insert the core-temperature probe into the food beforehand as described in the "Core-temperature measurement" section.

Press the "START/STOP" button.

- The LEDs of the "START/STOP" button flash.
- The LEDs of the "Regenerate" button illuminate.
- The top display shows the selected cooking temperature. The dot indicates that heating is activated.
- The top display for time/core shows the **remaining cooking time** (with continuous operation "---") or the **setpoint core temperature**.

### Completion of regeneration

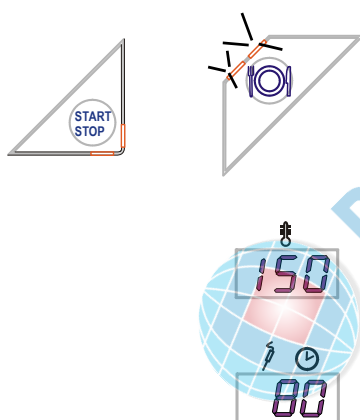

The cooking process is complete once the cooking time has expired or the core temperature has been reached.

The LEDs of the "START/STOP" button go out.

- The signal sounds continuously for 20 seconds. The signal can be switched off earlier by pressing the "START/STOP" button or opening the appliance door.
- The "Regenerate" button illuminates.
- Both displays then show the settings active when the process was started. **Changes made during the cooking process are not saved!**

The cooking process can be restarted by pressing the "START/STOP" button again.

## Display content during a cooking process

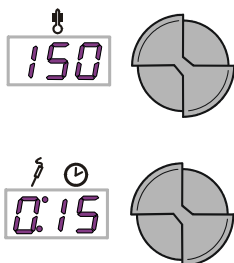

The elapsed time, actual cooking chamber temperature and actual core temperature can be displayed for 5 seconds during a cooking process by turning the adjustment knobs.

The **setpoint cooking chamber temperature**, **setpoint core temperature** or **remaining cooking time** is then displayed once again.

## Making changes during a cooking process



The **cooking time**, **setpoint cooking chamber temperature** and **setpoint core temperature** can be changed during a cooking process.

To make a change, press the cooking mode button: top display

- The button LEDs illuminate.
- The top display shows the previously selected **setpoint cooking chamber temperature** flashing.
- The bottom display shows the previously selected **setpoint core temperature** or **cooking time** flashing.

The temperature and time values can be changed with the adjustment knobs.

- Once the change is made, the top display shows the new **setpoint cooking chamber temperature**.
- The bottom display shows the changed **setpoint core temperature** or the **remaining cooking time** resulting from the changed cooking time.

Once the process is complete, the initial values are displayed; the changes made during the process are ignored.

The cooking process can be restarted with the original settings.



**Multi-step cooking programs** With the HD Silver, cooking programs with up to three cooking steps can be entered.

	<p><b>First program step:</b> Switch the Combisteamer on with the "ON/OFF" button.</p> <ul style="list-style-type: none"> <li>The LEDs of all four cooking mode buttons illuminate.</li> </ul> <p>Press the button for the <b>first cooking step</b> (e.g. Convection).</p> <ul style="list-style-type: none"> <li>The "Convection" button illuminates, and the other three go out.</li> </ul> <p>Set the temperature and time values with the adjustment knobs (see also "Convection cooking").</p>
	<p><b>Second program step:</b> Press the "STEP" button:</p> <ul style="list-style-type: none"> <li>The "STEP" button illuminates.</li> <li>All four cooking mode buttons illuminate.</li> <li>The top display shows "StP" for step.</li> <li>The bottom display shows "2" for the second step.</li> </ul> <p>Press the button for the <b>second cooking step</b> (e.g. "Steam").</p> <ul style="list-style-type: none"> <li>The "Steam" button illuminates, and the other three go out.</li> <li>The "STEP" button continues to illuminate.</li> </ul> <p>Set the temperature and time values with the adjustment knobs (see also "Steaming").</p>
	<p><b>Third program step:</b> Press the "STEP" button:</p> <ul style="list-style-type: none"> <li>The "STEP" button illuminates.</li> <li>The four cooking mode buttons illuminate.</li> <li>The top display shows "StP" for step.</li> <li>The bottom display shows "3" for the third step.</li> </ul> <p>Press the button for the <b>third cooking step</b> (e.g. "Combisteam").</p> <ul style="list-style-type: none"> <li>The "Combisteam" button illuminates, and the other three go out.</li> <li>The "STEP" button continues to illuminate.</li> </ul> <p>Set the temperature and time values with the adjustment knobs (see also "Combisteaming"). The cooking program can be started once the third program step is set.</p>
	<p>You can check the steps already entered by repeatedly pressing the "STEP" button.</p>



## Starting multi-step program

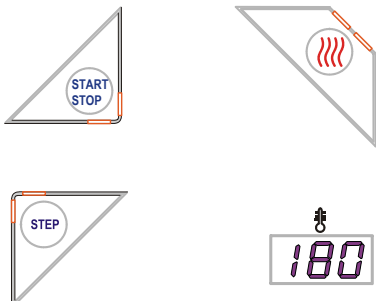

Start the cooking program with the "START/STOP" button after entering the second or third cooking step.

- The "START/STOP" button flashes until the last program step is complete.
- The illuminating "STEP" button indicates that a multi-step cooking program has been started.
- The button of the active cooking step illuminates.
- The setpoint cooking chamber temperature for the active cooking step is displayed in the top display.
- The bottom display shows the remaining cooking time or the SETPOINT core temperature for the active cooking step.

Once the cooking step is complete, the cooking button and the accompanying indications in the displays go out.

- The cooking mode button for the next program step illuminates.
- Both displays show the accompanying temperature and time values.

## Which program step is active?

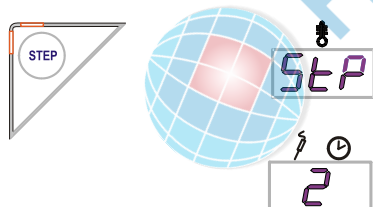

If you press the STEP button while the program is in progress, the number of the program step is displayed.

- The top display shows "StP".
- The bottom display shows "1, 2 or 3".

After approx. 5 seconds, the displays switch to the temperature and time values of the current program step.

## Completion of multi-step cooking program



When a multi-step cooking program is complete, the signal sounds for approx. 20 seconds. The signal can be switched off (acknowledged) by opening the appliance door or pressing the \_\_\_ button.

- All displays go out.
- The STEP button illuminates.
- The cooking mode button of the first program step illuminates.

## Restarting multi-step cooking program

The last completed cooking program can be restarted by pressing the START/STOP button.

If the Combisteamer is switched off, all input is deleted, i.e. cooking programs cannot be saved.

## Core-temperature measurement

### Which cooking process should use core-temperature measurement?

The core-temperature measurement is especially recommended when cooking slow-cooked roasts.

When cooking with HansDampf, the core-temperature measurement (CTM) can be used with all cooking processes. Here, the temperature is measured with a probe inserted down into the core of the food being cooked and compared to the (selected) core temperature to be reached. As soon as the core temperature has been reached, the power and water supplies of the steamer are shut off.

The advantages here include:

- minimal power and water consumption
- no overcooking
- minimal loss of cooked food weight

MKN recommend using CTM with all cooking methods if possible.



**To ensure that the setpoint core temperature is reached, the cooking temperature must be set at least 5 °C higher.**

## Core-temperature probe versions

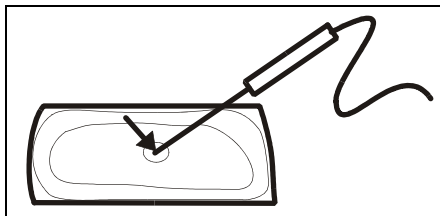

Single-point core-temperature probe at the core of the food

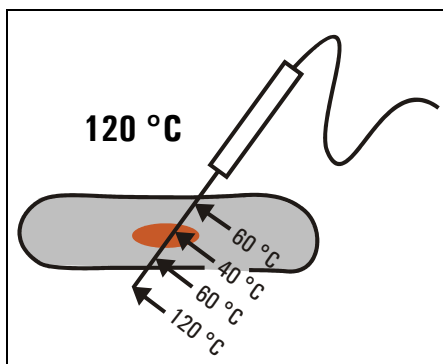

Temperatures at the four-point core-temperature probe at 120 °C cooking chamber temperature

The HansDampf Silver is equipped with a **single-point core-temperature probe** as standard.

The tip of the single-point probe must be inserted as closely as possible to the core of the food.

Optionally, the Combisteamer can be equipped with a **four-point core-temperature probe**.

The tip of the four-point probe can lie somewhat outside the core (which is usually the case), as it measures at four points and the coldest measurement point is used to control cooking

## Positioning the core-temperature probe

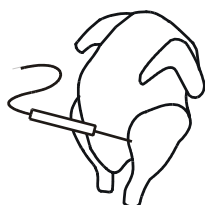
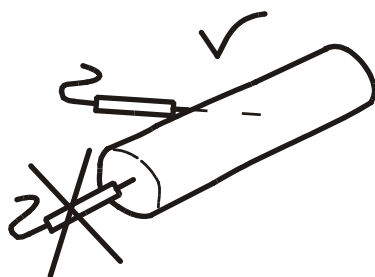
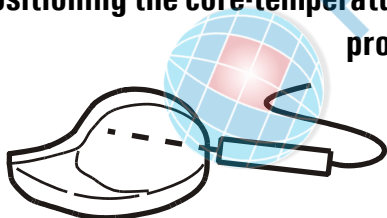

When cooking several roasts, always position the core-temperature probe in the **centre of the cooking chamber** (centre insertion level).

Insertion into the **food** should always occur where it is largest. For roasts with bones, e.g. cutlets, insert it as close to the bone as possible (isolate bone).

For longish roasts, e.g. smoked pork chop strips, insert probe crosswise. With longitudinal insertion, a hole would remain in the centre of the cut upon carving.

For poultry (with differing distribution of mass), e.g. chicken, insert probe at the interior side of the haunch. The probe should always be fully inserted, as otherwise erroneous measurements are possible.

### Making changes to settings

#### Default settings

The preset values of the control electronics can be changed within certain limits.

#### Calling up setting menu

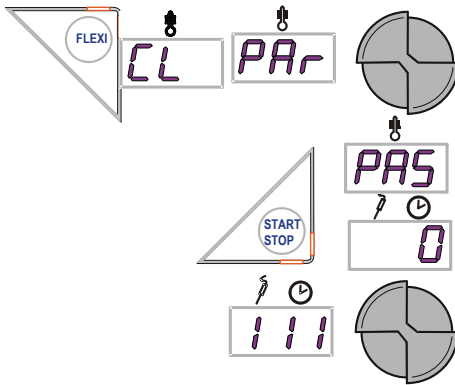

Press the "FLEXI" button with the appliance switched on.

- The top display shows a flashing "CL" or "CLE"
- Select the "Par" menu item with the adjustment knob and accept it by pressing the START/STOP button.
- The top display shows "PAS" for password.
- The bottom display shows "0".

Set the password "111" in the bottom display with the adjustment knob.

#### Selecting parameters

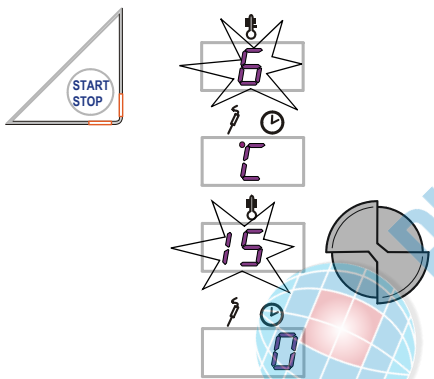

Press the "START/STOP" button after entering the password.

- The top display shows the first parameter flashing.
- The bottom display shows the parameter value.
- Select the parameter with the top adjustment knob.
- The top display shows the selected parameter flashing.
- The bottom display shows the parameter value.

#### Changing parameters

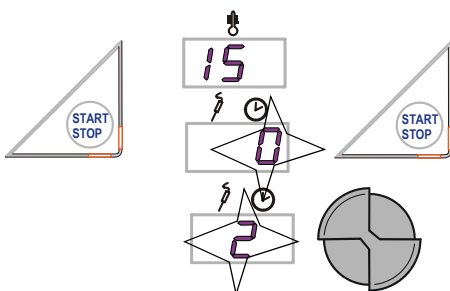

Press the "START/STOP" button after selecting the parameter.

- The top display shows the selected parameter.
- The bottom display shows the preset parameter value flashing.

Select the value from the parameter list with the adjustment knob.

Press the "START/STOP" button to change another parameter.

#### Accepting parameters

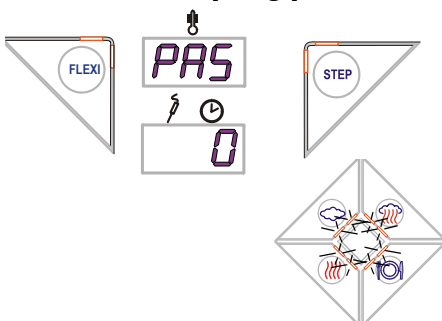

Accept the changed parameter(s) by pressing the "FLEXI" button.

- "PAS" appears in the top display.
- "0" appears in the bottom display.

Exit the setting menu by pressing the "STEP" button.

- The four cooking mode buttons illuminate, and the Combisteamer is in switch-on mode once again.

## Parameter list Start display

Parameter	No.	Presetting	Setting range	Explanation
Time/Date (optional)	000	Local time of owner	Time/Date	Automatic Daylight Savings Time switching For date format, see parameter No. 44
Preheat factor %	082	15	0-30%	If fully loaded with large pieces of food (roasts, loaves of bread), increase preheat factor to avoid great increases in temperature.
Temp. reading	006	ℓ	°C/°F	The temperature reading in °F is not bound to the English display text.
Time delay fan	032	oFF	Off/On	If "On", the fan cycles through during time pre-selection with an ice block in the lowest insert to cool the cooking chamber. For this purpose, place perforated container into the closed container, add approx. 4 L drinking water and let freeze. Insert ice block into the perforated container on the lowest level. A temperature of 14 °C can be maintained for up to 6 h with this
Cooling water	024	Std	Lo-Std-Hi	"Minimal" setting: Minimal water consumption, but higher condensation temperature and greater exhaust steam quantity. "Maximal" setting: Maximal water consumption, but low condensation temperature and low exhaust steam quantity.
Time Signal s	084	20	0 - 180	0 = signal off In addition to the signal, flashing of the START/STOP button can be activated (parameter 023)
Altitude	015	0	0=0 - 500 m 1=501 - 1000 m 2=1001 - 1500 m 3=> 1501 m	Obtain the altitude (via national node) from the closest weather station. If the altitude is unknown, set 0 - 500 m.
Password	096	111	000-500	Individual passwords can be set in this range.
Switch-on display	395	0	0-4	0 = all four cooking modes, 1 = steaming, 2 = combi-steaming, 3 = convection, 4 = regeneration
Temp. Steam	235	100	30 - 130 °C	The preset temperatures can be set individually for the cooking processes within the limits shown here.
Temp. Combi	236	150	30 - 250 °C	
Temp. Convec.	237	180	30 - 300 °C	
Temp. Regeneration	238	120	30 - 180 °C	
Scroll direction	225	1	Normal/Inverse	Direction of the combipilot in menus and the cookbook can be changed as desired.



PLATON SERVICE

8 (800) 500-34-41

[www.platonservice.com](http://www.platonservice.com)

## Additional functions

### Starting time pre-selection

The waiting time until the program starts can be set via the starting time pre-selection. To avoid bottlenecks during production and preparation, you can prepare the food as usual, load the **HansDampf** and enter the desired cooking program long before the cooking process is to begin.

The suitability of using time pre-selection must always be checked beforehand.

**If time pre-selection is used, temperatures can arise in the cooking chamber that contribute greatly to the growth of harmful bacteria on the food. This can spoil the food.**



#### Setting starting time pre-selection



Enter cooking program.

Press and hold the "START/STOP" button.

- "dLy" appears in the top display.
- "0:00" appears in the bottom display.

Using the rotary knob, enter the waiting time in the "h: min min" format.

#### Starting waiting time

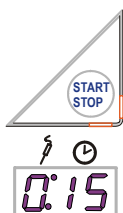

Start the waiting time by pressing the "START/STOP" button after entering the time:

- The LEDs of the "START/STOP" button illuminate
- The cooking chamber illumination is switched on.
- The remaining waiting time appears in the bottom display (countdown).

#### End of waiting time

Once the waiting time expires, the set cooking program is started automatically.

- The "START/STOP" button flashes.
- The button of the first cooking step illuminates.
- Both displays show the temperature and time values for the started program step.

#### Cancelling starting time pre-selection

The starting time pre-selection is cancelled and cleared with the "START/STOP" button.



### Preheating

Many cooking programs (e.g. baking) require the correct starting temperature. With the preheat program, the cooking chamber is heated to the correct starting temperature, regardless of the initial temperature.

After **briefly pressing** the Preheat button, the Combi-steamer is heated or cooled to the **cooking chamber temperature** of the first program step, which was **increased by 15%<sup>1</sup>**. After **pressing and holding the button** (min. 3 seconds), the cooking chamber is always preheated to **275 °C** regardless of the first program step.

#### Starting preheating

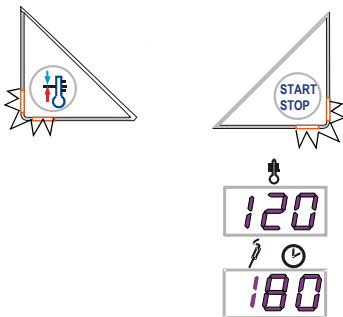

Press the Preheat button after entering the cooking program:

- The LEDs of the "Preheat" button flash.
- The LEDs of the "START/STOP" button flash.
- The **current cooking chamber temperature** appears in the top display.
- The bottom display shows the **setpoint cooking chamber temperature**

#### Completion of preheating

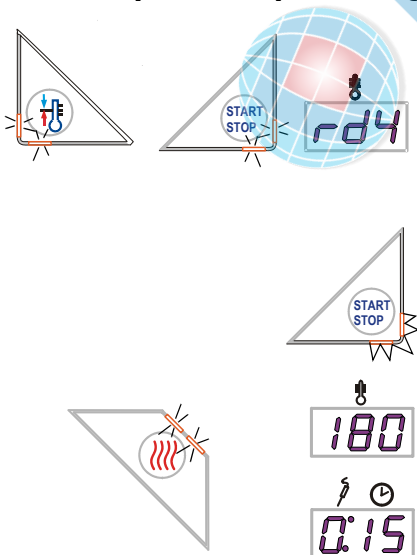

The buzzer sounds when the start temperature is reached:

- The LEDs of the "Preheat" button illuminate.
- The LEDs of the "START/STOP" button illuminate.
- "rdy" appears in the top display.

Open the appliance door, insert the food and close the door again. The program sequence starts automatically.

- The START/STOP button flashes
- The temperature and time values for the first cooking step appear in the displays.
- The LEDs of the cooking mode button illuminate.

**Preheating cannot be entered as a cooking step. It must be started manually!**

### Manual steam injection

With all cooking programs except "Steaming", manual steam injection is possible during operation. Press the "Steam" button for steam injection.

1. This addition can be changed as described in "Making changes to settings".



# Practical tips

## Steaming

With the "Steaming" program, you can steam, soft steam, express steam, i.e. cook, steam, blanch, poach and preserve.

### Advantages of steaming

- You get food in vibrant colours with a firm consistency and an intense, unique flavour.
- Steaming allows vitamins and minerals to be retained in food to a high degree.
- Flavours do not mix when steaming different foods, e.g. vegetables and fish, in a single load.
- Fewer spices and less oil/butter and salt are required.
- You work quickly, as the steam is produced very quickly.

### Important information to be heeded



- Perforated GN containers with a depth of 40 - 65 mm are ideal for steaming. They ensure short cooking times and prevent food at the bottom of the GN container being overcooked.
- Break up frozen clumps if the food is frozen so that everything is cooked at the same rate.
- If you steam different foods in a single load, you should comply with the cooking times of each individual food type.
- When preserving, the cooking time depends on the product type, package size and consistency. The **HansDampf** is ideal for creating  $\frac{1}{2}$  to  $\frac{3}{4}$  preserves. Please use the usual method for preserving.

### Steaming tips

- Rinse (with cold water), butter and season **vegetables** after steaming.
- For **vegetables in liquid**, use the stock. Steam the vegetables in perforated containers and catch the stock in inserted, non-perforated containers.
- **Long grain rice** is steamed in non-perforated containers. For every one part rice, you will require  $1\frac{1}{2}$  parts cold water or cold stock for boiling.
- **Durum wheat noodles** are steamed in non-perforated containers. For every one part noodles, you will require at least five parts water for boiling.

- **Dumplings** are to be placed on perforated containers covered with baking paper. Cover immediately after cooking. If distributed over a long period, keep warm in water bound by starch.
- Sprinkle **potatoes** with fine salt immediately before steaming and mix or place in saltwater for 15 minutes.

## Soft steaming

### Advantages of soft steaming

- Especially careful preparation of food.
- Reduction in the loss of meat and sausage weight with optimal taste, aroma and colour.
- Prevention of burst skins when boiling or heating up sausages.
- Optimal food quality with sensitive foods such as terrines, gelatines, flan, forcemeat dumplings, crème caramel and diet foods.
- Ideal for use with vacuum pouches with the Sous-Vide method.
- The protein coagulates optimally with degree-precise cooking, i.e. it is retained in the food.

### Important information to be heeded

### Soft steaming tips

- Keep in mind that the cooking time is longer than with steaming at 100 °C.
- Allow pieces of yeast, bread or flaky-pastry **dough** to leaven at a temperature setting of 32 °C.
- You can soak **grain** carefully for whole-food preparations, like muesli.
- Poached **trout** is created by pouring vinegar or wine over trout.
- You can boil **ham** and **sausages**.

## Express steaming

### Advantages of express steaming

- Express steaming is primarily intended for tougher foods, such as potatoes with their skin, red beets, rutabagas, legumes and cabbage.
- Cooking times are shorter by 10% in comparison to steaming at 100 °C.

### Important information to be heeded

- With a small load of food, select a cooking chamber temperature between 105 °C and 110 °C, and select a temperature between 110 °C and 130 °C for a full load.

### Express steaming tips:

- Use lidded GN containers for careful preservation of **pre-portioned foods** with the shortest cooking times.

## Combisteaming

In the "Combisteaming" program, you roast large roasts, cook casseroles etc..

### Advantages of combisteaming

- Always an optimal cooking chamber climate with combisteaming.
- Food does not dry out.
- The taste and aroma of the food remain in tact to the greatest degree possible.
- Food is cooked very quickly with minimal loss of weight.
- Flavours do not mix if you are cooking different foods in a single load. Mixed loads are possible at any time.
- Bakery products, such as yeast, puff-pastry and bread dough rise optimally during baking.
- The pores of large roasts close immediately due to the steam, which makes browning unnecessary.



### Important information to be heeded

- Preheat the **HansDampf** for at least 10 - 15 minutes with the Preheat function before baking.
- The higher the cooking chamber temperature, the more intensively the food will brown, and the greater the loss in weight.
- Food begins to brown at temperatures of 120 °C and above.
- Reduce the cooking chamber temperature by 20 - 30% in general in comparison to traditional cooking methods.

### Combisteaming tips

- Place **roasts** on grills. This allows the pores of the roasts to close on every side. This results in even cooking results without having to turn the roasts.
- Insert a trough under the grills with roasts to catch the juices for use as sauce or sauce starter. Add bones, mire poix (roasted vegetables) and spices to this and add water or stock bit by bit.

### Convection

The "Convection" program is ideal for all roasts and baked goods not requiring additional humidity.



- Large capacity.
- Even cooking results thanks to the auto-reserve impeller.
- Up to 95% less oil/butter is required in comparison to conventional cooking methods.

### Important information to be heeded

- Preheat the **HansDampf** for at least 10 - 15 minutes with the Preheat function before cooking.
- The higher the cooking chamber temperature, the more intensively the food will brown, and the greater the loss in weight.

### Convection cooking tips:

- When cooking breaded foods, it is best to use convenience products suitable for convection or coat breaded products with browning greases.

### Regeneration

With this program, you can regenerate entire GN containers, in addition to food on dishes or platters, in a short amount of time.

#### Advantages of regeneration

- Regeneration always provides the optimal cooking chamber climate.
- You create the food during quiet and slow periods and portion it onto dishes or platters.
- The food does not need to be kept warm. This means there is no drop in quality.
- The portioned foods do not dry out during regeneration.
- Neither condensation puddles nor dry edges form on the dishes.
- For banquets, you can regenerate any number of dishes as needed.
- The banquet dish trolley can be loaded easily from all sides.

#### Important information to be heeded



- Always bring the **HansDampf** to the correct starting temperature with the preheat function.
- For regeneration times and temperatures, please refer to the following table.
- Large, compact food components, like dumplings, roulades and casseroles take longer to regenerate than, for example, slices of roast, vegetable sides, rice and quartered or turned potatoes.
- Distribute food items on the dish evenly and in small individual pieces. Avoid heavy overlapping and different heights of the items.
- Pour sauces onto the dishes with a sauce dispenser after regeneration.

### Regeneration tips

- Place **fish** and **meat** on a base so that they regenerate evenly and do not stick to the dish.
- Pre-roast the **meat** à point if it is to be cooked medium after regeneration.
- **Vegetables, rice** and **noodles** should be seasoned, and butter/oil added, before regeneration.
- Cut off compact **pieces**.
- Use a **thermal hood** for longer transport distances. Place the thermal hood over the **HansDampf** before use for pre-warming.
- Use multiple banquet dish trolleys for **larger banquets**. You can keep dishes warm for up to max. 20 minutes with thermal hoods. 15 minutes is ideal. You can regenerate additional batches during this time. This allows you to serve food to your guests at the same time.
- Save the optimised regeneration programs of standard dishes in the regeneration cookbook. This guarantees smooth running of banquets or à la carte service.

### Regeneration guidelines

The regeneration time and temperature are dependent on the number of dishes.



HansDampf Model	With regeneration grill Dishes up to dia. 28cm	With banquet trolley Dishes up to dia. 32 cm	Regeneration temperature	Regeneration time
HD 6.1/6.2	24	22	120–130 °C	4–8 min.
HD 10.1/10.2	40	40	120–130 °C	4–8 min.
HD 20.1	80	80	120–130 °C	6–10 min.
HD 20.2	120	80	120–130 °C	6–10 min.

# Cleaning

## Safety information



Clean the appliance after every use, but switch it off before doing so!

Do not spray appliance off/out with a high-pressure jet (water/steam)!

Do not use scouring agents, cleaning sponges or chemically aggressive agents to clean the keypad film of the operating field!

Do not leave the cleaning agent in the appliance for a longer period of time!



### Danger of fire from grease coatings!

With some cooking processes, e.g. the grilling of chicken, heavier grease coatings can arise inside the cooking chamber and on the outer housing. This increases the risk of fire, which is why the appliance must be regularly cleaned (after every cooking process, if necessary) and kept free of grease!

## Cleaning outer housing



Wipe off the outer housing with lukewarm soapy water and a cloth. Do not use scouring agents or cleaning sponges.

The in-built hand shower (optional) or an external hand shower may only be used to rinse out the cooking chamber. The outer housing may not be sprayed with them!

## Cooking chamber cleaning systems

The **HansDampf Silver** is delivered with a program for **user-guided manual cleaning** of the cooking chamber as standard.

**Optionally**, the **HansDampf Silver** can be outfitted with the **automatic cleaning system known as "WaveClean"**. Cleaning and rinsing of the cooking chamber occur automatically here<sup>1</sup>.

If it is equipped with **WaveClean**, user-guided manual cooking chamber cleaning is deactivated.

The cooking chamber cleaning system that has been supplied with the Combisteamer can be shown in the

1. For technical reasons, the exterior side of the door seal is not cleaned automatically, i.e. it must be cleaned separately after every cleaning (manually or WaveClean) as described in "Cleaning door seal"!

top display by pressing the FLEXI button when the appliance is switched on:

CLE = user-guided manual cooking chamber cleaning system

CL = WaveClean cooking chamber cleaning system. With WaveClean, there are two additional receptacles for the cleaning cartridges in the cooking chamber.

Outfitting with an in-built hand shower (**optional**) is recommended for both cooking chamber cleaning systems.

### Cleaning the door



#### **Danger of burns!**

**The door is hot after cooking!**

**Allow it to cool before cleaning!**

**Do not spray down the door with cold water to accelerate cooling!**

The glass panes are provided with a special infrared-reflective coating.

**Do not use a scouring cleaner or cloth** for cleaning.

**Do not use grill cleaner**, as it can cloud the surface of the glass.

Lime residue on the glass pane can be removed with vinegar or citric acid.

### Back-ventilated door



With the two-component back-ventilated door, the inner pane can be swivelled out so that the interior surfaces of the panes can be cleaned.

Open the door 90°, push open retaining springs [1] and swivel out inner pane 90° [2].



#### **Inner pane:**

- may not be swivelled open fully!
- may not be lifted when being swivelled out!
- must be held firmly while being cleaned!

After cleaning, push the inner pane closed again so that it is held in position by the springs.

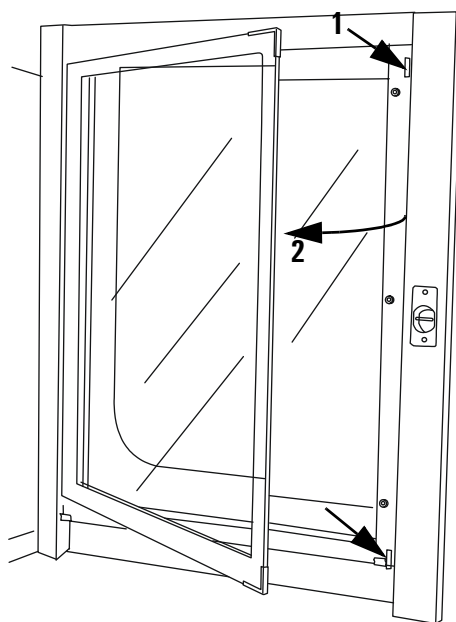



### Removal and installation of the inner pane:

Attention: The pane is heavy! With floor-mounted appliances, removal and installation are to be carried out by two people. Remove only when cold.

Lift the inner pane approx. 10 mm when folded out. The lower pane bearing can now be swivelled out. Now lower the door and remove it from the door frame.

Installation is carried out in reverse order.

### Cleaning door seal

In conjunction with high temperatures, animal greases can damage the door seal in short order. Regular care is necessary to ensure a long service life. Always remove grease from the door seal with a moist cloth at the end of operation. Do not use an aggressive cleaner here.



**If the appliance is primarily used for roasting, the door seal must also be cleaned during pauses in operation.**



PLATON SERVICE  
8 (800) 500-34-41  
www.platonservice.com

### User-guided manual cleaning

#### Preparation of cooking chamber

With the **HansDampf 20.1**, insert the transport trolley without baking sheets, grills or insertable containers. With **models 6.1 and 10.1**, leave only the slide-in frames in the cooking chamber.



**Remove baking sheets, grills and insertable containers from the cooking chamber before manual cleaning!**

Do not insert baking sheets, grills or insertable containers for cleaning. These must be cleaned separately, e.g. in a dishwasher.

#### Starting manual cleaning

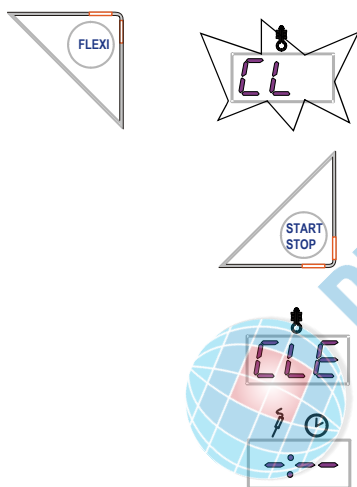

Press the "FLEXI" button after switching on the Combisteamer or when a cooking process is complete.

- The top display shows "CLE" flashing.
- The bottom display remains dark.

Start manual cleaning when the START/STOP button is pressed.

If the cooking chamber is too hot, the appliance will be cooled automatically. If it is too cold, it is heated to the soaking temperature. The top display shows "CLE" (manual cleaning).



**Do not cool down a hot cooking chamber by spraying in cold water or filling with ice!  
Abrupt cooling can deform the cooking chamber and burst the insulating glass pane of the door.**

**Cooking chamber too hot**



**Do not cool down a hot cooking chamber by spraying in cold water or filling with ice! Abrupt cooling can deform the cooking chamber and burst the insulating glass pane of the door.**

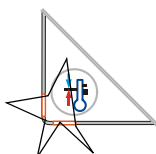
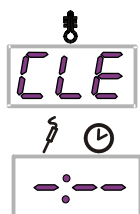

Manual cleaning starts with the soaking program when the cooking chamber temperature has reached 50 °C. If the temperature is above or below 50 °C, the cooking chamber is cooled or heated until it has reached a temperature of 50 °C.

- "CLE" appears in the top display.
- "--:--" (unlimited preheating/recooling time) appears in the bottom display.
- The Preheat and START/STOP buttons flash.

**Soaking**

As soon as the start temperature is reached, the signal sounds for a short time and the soaking program is started.

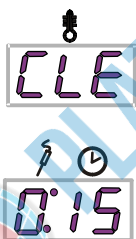

**Spraying in cleaner**

- Preheat and "START/STOP" buttons have gone out.
- "CLE" appears in the top display.
- The remaining soaking time appears in the bottom display (countdown).

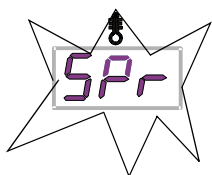

**Danger of chemical burns!**

Always wear protective clothing, protective gloves and face protection when spraying strong chemical cleaners and decalcifying agents! Also wear breathing protection to protect yourself against aerosols and vapours!

When soaking is complete, the prompt to spray in the cleaner appears via "SPr" in the bottom display.



- Open the appliance door and unlock and open the air deflector.
- Spray the heating register and fan impeller with cleaner.
- Close the air deflector and lock it again.
- Spray the interior with cleaner.
- Close the appliance door again.

### Cleaning (working in)

The cleaning (working in) time starts once the door is closed.

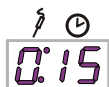

**!** Do not allow the cleaner to work in longer than specified by the program, as it can also attack stainless steel!

- The remaining time appears in the bottom display.

### Cleaning

The actual cleaning process begins after 15 minutes of working-in time (operating mode: Steaming). The cooking chamber is heated to 80 °C here.

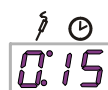
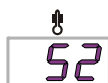
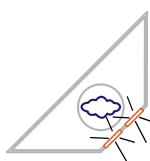

- The "Steam" cooking mode button illuminates.
- The top display shows the current temperature.
- The bottom display shows the remaining time.

### Rinsing

Once the cleaning process for working in is complete, the prompt to rinse out the cooking chamber appears via "Sho" in the bottom display.



- Open the appliance door and unlock and open the air deflector.
- Thoroughly rinse (at least 3 min.) the interior, heating register, fan impeller and inside the appliance door with a hand shower.
- Close the air deflector and lock it again.
- Close the appliance door again.



### Drying

Drying is started as soon as the door is closed (convection at 130 °C, 5 minutes). The cooking chamber is heated to 130 °C here.

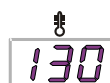
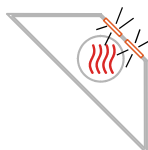

- The Convection button illuminates.
- The top display shows the current cooking chamber temperature.
- The bottom display shows the remaining drying time.

## Manual cleaning

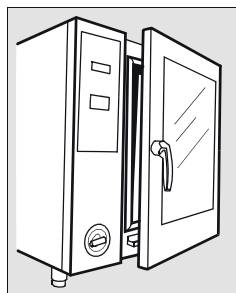
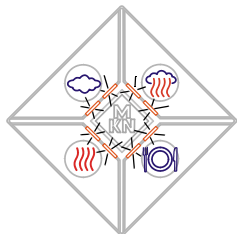

Manual cleaning ends with drying.

The prompt to open the appliance door appears via a flashing "oPE" in the bottom display.

Open the appliance door.

- The bottom display goes out
- The four cooking mode buttons illuminate

Switch the Combisteamer off with the ON/OFF button.

Open the appliance door and leave it open slightly until the next time it is used. This extends the service life of the door seal and prevents stale moisture accumulating in the cooking chamber.

## Decalcification



To prevent lime deposits in the cooking chamber, only softened water should be used for operation of the HansDampf. If hard water is used, the cooking chamber must be decalcified regularly to prevent damage to the appliance. MKN offer a special decalcification solution for this purpose. Dilute special decalcification solution to 5% with water and spray into the cold (<math>< 40\text{ }^\circ\text{C}</math>), cleaned cooking chamber. Open the air deflector so that the components located behind it are used.

Thoroughly rinse the cooking chamber after a working-in time of 30 min. Repeat decalcification if necessary. Dry the cooking chamber after rinsing as described above.

## WaveClean cleaning (optional)

### "two-in-one" combination cartridge

"WaveClean" is an automatic cleaning system whereby the cooking chamber is cleaned and fully rinsed with a combination cartridge ("two-in-one"). Only this original cartridge may be used for this purpose. We are not liable for damage caused by the use of other products.

### Storage of cartridges

Store cartridges under lock and key in accordance with the hazardous materials regulations. Store under 40 °C, on their lids and protected from moisture and direct sunlight.

### Preparing cooking chamber



**The strainer of the floor drain must be unobstructed!**

Any food residue covering the strainer of the floor drain must be removed before the cleaning process can begin.



**Do not insert containers before commencing with "WaveClean" cleaning!**



With the **HansDampf 20.X**, insert the transport trolley into the cooking chamber. For **models 6.X and 10.X**, leave only the slide-in frames in the cooking chamber and close the door. Do not insert baking sheets, grills or insertable containers. These must be cleaned separately, e.g. in a dishwasher. Inserted containers catch the cleaning water and thus interrupt the cleaning circuit. This can cause the pumps to run dry and be damaged!

## Selecting cleaning level

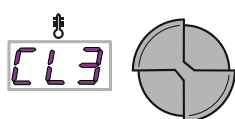
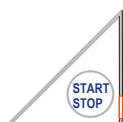

Press the "FLEXI" button after switching on the Combisteamer or when a cooking process is complete.

- The top display shows "CL" flashing
- The bottom display remains dark.

Press the START/STOP button.

- "CL1" is displayed in the top display for the first WaveClean cleaning stage

Select the cleaning stage with the adjustment knob:

CL1-> WaveClean, short:	approx. 1.0 h
CL2-> WaveClean, standard:	approx. 2.0 h
CL3-> WaveClean, extra:	approx. 3.0 h

Despite different cleaning times, all programs require the same amount of water.

## Starting WaveClean

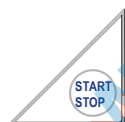

Press the "START/STOP" button after selecting the cleaning stage. If the cooking chamber is too hot when starting occurs, it is cooled down first (see "Cooking chamber too hot").

If the cooking chamber is at the starting temperature, cooling is skipped and insertion of the cartridges is continued (see "Inserting cartridge").

## Cooking chamber too hot

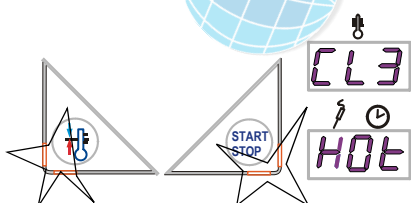

**Do not cool down a hot cooking chamber by spraying in cold water or filling with ice! Abrupt cooling can deform the cooking chamber and burst the insulating glass pane of the door.**

"WaveClean" does not start until the cooking chamber temperature is 50 °C or below.

If the temperature in the cooking chamber is over 50 °C, it is automatically cooled.

- "Hot" appears in the bottom display.
- Preheat and START/STOP buttons flash.

The signal is sounded briefly when the start temperature is reached.

- Preheat and START/STOP buttons go out.
- "CAr" appears flashing in the bottom display.

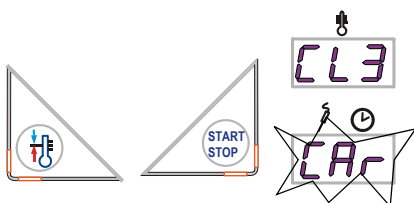

### Inserting cartridge

The flashing "CAR" in the bottom display prompts the insertion of the cartridge.

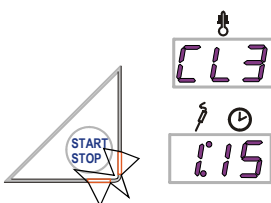
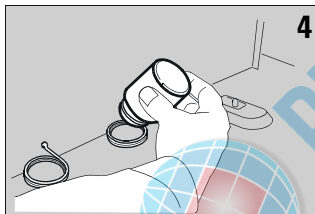
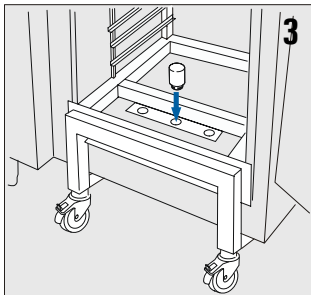
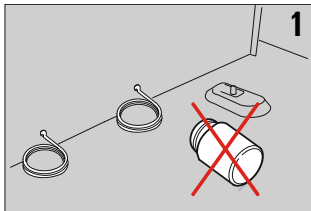
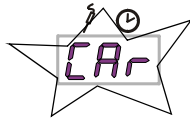

**Do not insert the cartridge until prompted to do so!**

- ! **Insert cartridge into the holder; do not place on the floor!**
- ! **Start the cleaning program directly after inserting the cartridge! If starting is delayed, the wax seal can melt due to the residual heat in the cooking chamber!**

Use only cartridges with an unbroken wax seal. If the wax seal is damaged [2], the cleaner can end up in the cleaning circuit prematurely or not fully dissolve, in which case full cleaning is no longer guaranteed. In case of heavy soiling, you can insert two cartridges and select **WaveClean extra**.

Screw off the lid of the cartridge, open the door and insert a cartridge:

- with model 20.X, in the transport trolley holder [3]
- with models 6.X and 10.X, in the receptacle [4] below at the fan cover.

Close the door again:

- The START/STOP button illuminates and the Combi-steamer is ready for operation (standby).
- The top display shows the cleaning stage
- The bottom display shows "CAR" flashing

Start WaveClean by pressing the START/STOP button:

- The START/STOP button flashes
- The top display shows the cleaning stage, e.g. "CL3"
- The bottom display shows the remaining cleaning time (countdown)



## Cancelling "WaveClean"

For safety reasons, cancellation of "WaveClean" is always followed by automatic forced rinsing. A power failure during cleaning also leads to cancellation of the program with subsequent rinsing. Cancellation is not possible during cartridge activation.

"WaveClean" is cancelled by pressing the STEP button.

- The cooking chamber is rinsed for approx. 5 minutes.
- The prompt to remove the cartridge appears via "CAr" in the bottom display.

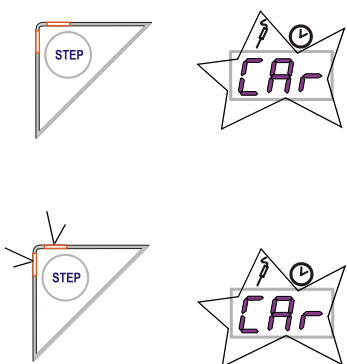

When rinsing is complete, open the appliance door and remove the cartridge. Close the door again.

- The STEP button illuminates
- The bottom display shows "CAr" flashing

Confirm removal of the cartridge by pressing the STEP button.

- The STEP button goes out.
- "CAr" disappears from the bottom display.

The Combisteamer is in switch-on mode once again.

- The four cooking mode buttons illuminate.

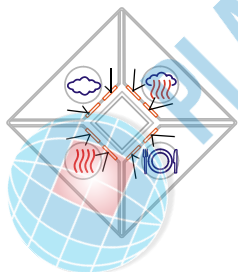

### Completion of "WaveClean"

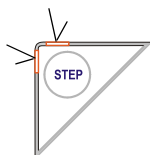

Once "WaveClean" is complete, the Combisteamer remains in standby mode.

- The STEP button illuminates.
- The prompt to remove the cartridge appears via "CAR" in the bottom display.

Open the door and remove the empty cartridge. Thoroughly rinse out any residual cleaner or rinse water with a hand shower.

Close the door again, and confirm removal of the cartridge by pressing the STEP button.

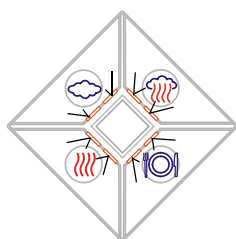

- The STEP button goes out.
  - "CAR" disappears from the bottom display.
- The Combisteamer is in switch-on mode once again.
- The four cooking mode buttons illuminate.



PLATON SERVICE  
 8 (800) 500-34-41  
 www.platonservice.com

## "WaveClean" malfunctions

Malfunction	Possible cause	Remedy
<ul style="list-style-type: none"> <li>• Cartridges do not activate properly</li> </ul>	Appliance is tilted	Align appliance horizontally
	Power failure Appli. malfunction	Service
<ul style="list-style-type: none"> <li>• Residual cleaner and rinse water remain in the cartridge</li> </ul>	Cartridge too close to floor due to bent holder	Bend cartridge holder back into place
	Heater defective	Service
<ul style="list-style-type: none"> <li>• Rinse water activates with the cleaner</li> </ul>	Circulation pump defective	



Brown/black discolouration of the cooking chamber floor may occur below the cartridge. This discolouration is harmless and has no negative effects. Leave door open slightly until the next use. This extends the service life of the door seal and prevents stale moisture accumulating in the cooking chamber.

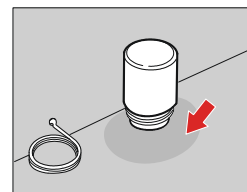

## Lime depositing with "WaveClean"



The Combisteamer can be operated up to 5 DH without additional water treatment measures. Water with a total hardness greater than 0 DH, however, contains lime, which can build up in the cooking chamber over time.

Even if "WaveClean" cleaning or manual cleaning occurs comparatively infrequently, the quantity of lime deposited is so small that, from a technical standpoint, the appliance generally experiences no negative effects. White deposits (lime) can appear in the cooking chamber, however.

## "WaveClean extra"

The "two-in-one" cleaning cartridge has been optimised for the removal of especially strong grease soiling and burnt-in soiling. It can only dissolve a certain amount of the lime residue. The cooking chamber can remain white with excessive quantities of lime.

In this case, regular cleaning with "WaveClean extra" (e.g. daily) should be carried out, even if the degree of soiling is low.

**Additional rinse water cartridge** In addition to the "two-in-one" cartridge, a rinse water cartridge (MKN No. 303 325) can be used. This increases the lime-dissolving power during "WaveClean" cleaning.

**Manual decalcification** If the lime is no longer dissolved through these measures, it must then be removed manually with a liquid decalcifying agent.

We recommend the MKN special decalcifying agent (Part No. 303326) in conjunction with the manual spray pistol (Part No. 303323) for this purpose.

Subsequent cleaning with "WaveClean extra" and an additional rinse water cartridge should always be carried out.

**Water softening** An additional measure for the prevention of lime deposits is the softening of the soft water to 0 DH.



PLATON SERVICE  
8 (800) 500-34-41  
www.platonservice.com

# Malfunctions

**Fault display** If a fault occurs during operation, the fault number is displayed flashing in the top display.



No.	Fault message	Cause	Remedy
66	No water	Water valve closed, Appliance defective	Water valve open Contact customer service
9	Cooking chamber over-heated	Appliance defective	Stop using appliance. Contact customer service
11	Electronic to warm	Cooling defective, Ambient temperature too high	Appliance can be used, set lower temperature. Contact customer service
10	Electronic to hot	See above	Appliance can no longer be used. Contact customer service
1	Core temperature defective	Probe defective	Cooking programs without core temperature can still be used. Contact customer service
2 or 3	Cooking chamber probe defective	Probe defective	Cooking programs without core temperature can still be used. Core-temperature probe used as replacement probe. Do not insert core-temperature probe into products. Core-temperature probe must remain in cooking chamber. Contact customer service
30	No fan	Fan does not rotate. Phase missing. Appliance defective	Check whether electrical connection is in order (fuses). Otherwise, contact customer service
8	Ice damage risk	Temperature $< 0^{\circ}\text{C}$	Operate appliance at temperatures $> 0^{\circ}\text{C}$ only. Lines and components can be damaged by frost.
101	Battery empty	Buffer battery empty. Average service life: 8 years	Settings are lost without a power supply. Otherwise, normal operation is possible. Contact customer service
-C-	Perform configuration	Electronics were replaced, but the necessary configuration was not carried out.	Contact customer service. Configuration must be carried out
5	Drain temp. probe defect	Temperature measurement of drain water defective. Cooling water is permanently switched on. Otherwise, normal operation is possible	Contact customer service
121	HW-Fail Temp UREFO too high	Core-temperature probe or keypad defective	Replace core-temperature probe or keypad, call customer service

**Resetting (initialising) control electronics**

Faults in program running (e.g. specified values not complied with) can be remedied by switching off and then on again.



**PLATON SERVICE**

8 (800) 500-34-41

[www.platonservice.com](http://www.platonservice.com)

## HACCP

**Printing logs** The **HansDampf** saves up to 200 HACCP logs, depending on the number of program steps.

The logs can be printed out with<sup>1</sup> a serial mini-printer via the RS 232 serial interface. The RS 232 connection cable may be no longer than 3 m.

Log number gaps can arise in the HACCP memory. They are generated by cooking programs under 1 minute. These are not logged.

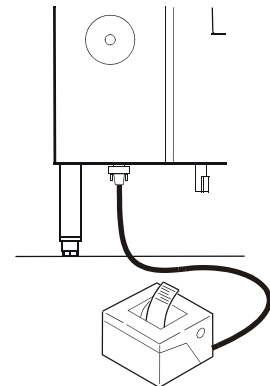

PLATON SERVICE  
8 (800) 500-34-41  
www.platonservice.com

---

1. Serial printer, 40 columns, RS 232 interface,  
Setting: 9600, N, 8,1

**The HACCP log** Core-temperature values are also printed out grouped in hour blocks. The cycle time (5, 10 or 15 min) is output after the time of day.

Pressing and holding prints the logs from the selected one to the newest one ("000") (for a day or week overview).

The data can also be transferred to a PC as a text file. A terminal program is to be started on the PC for this purpose (e.g. Hyperterminal).



Appliance No.: 01234567  
 Appliance type: 6.1  
 Print date: 23/06/2003  
 Abbreviation: CM = cooking mode,  
 S = Steaming,  
 CS = Combisteaming,  
 HC = Convection  
 R = Regeneration,  
 CT = Core temperature

: knuckles  
 Cooking date: 19/06/2003 8:59 End:  
 10:38  
 Cooking time: 1:39

Step No.	Temp	Time	Temp		Time	
			Min, Max	CT	set	act.
1	S		96, 133	-	1:00	0:49
2	CS		99, 99	75	-	0:00
3	CS		99, 161	85	-	0:11
4	CS		157, 179	90	-	0:06
5	HC		179, 199	95	-	0:27

Core-temperature values

8:59 45, 25, 30, 38, 45, 52 5 min.  
 58, 62, 68, 72, 75, 78 5 min.  
 9:58 82, 84, 89, 92, 93, 94 5 min.  
 94, 95 5 min.

Special event: Door was opened

**Annotations:**

- Operating**: Points to the globe icon.
- Step No.**: Points to the first column of the table.
- Minimal and maximal temperature with this step**: Points to the 'Temp' column of the table.
- Time at the setpoint temperature**: Points to the 'set' column of the table.
- Set setpoint time**: Points to the 'act.' column of the table.
- Core-temperature setpoint value**: Points to the 'CT' column of the table.
- Polling interval**: Points to the '5 min.' values at the bottom of the log.
- Special event**: Points to the 'Door was opened' entry.